



B METERS srl

Via Friuli, 3
 33050 Gonars (UD)
 Italy

Tel: +39 0432 931415
 Tel: +39 0432 1690412
 Fax: +39 0432 992661

Sales/info: info@bmeters.com
 Support: ticket@bmeters.com
 www.bmeters.com

Index

1. Content	2	3. Radio parameters	5
Design	2	Delivery status	5
Device dial	2	Operating mode - Radio activation.....	5
Functionality	2	4. Device display loop	6
Types.....	3	5. Error message	7
Packing content	3	6. Batteries safety guidelines	8
Safety conditions	3	7. Information for correct disposal of the product	9
Environmental conditions	3	8. Technical data	9
Installation requirements.....	4	Annex A	10
2. Function	5		
Display.....	5		

1. Content

Design

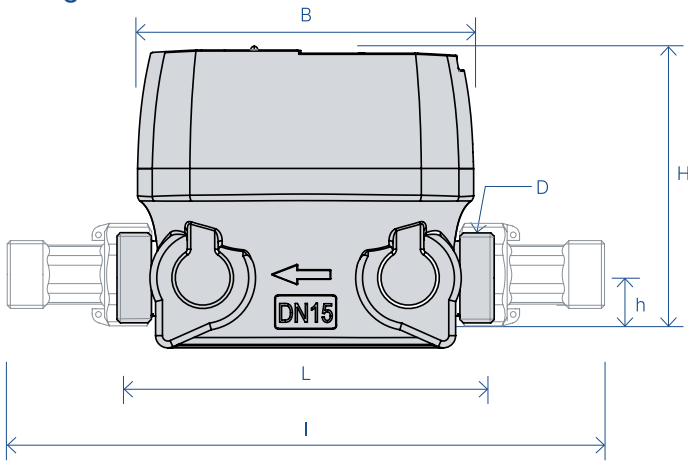

Size		15mm (1/2")			20mm (3/4")	20mm (3/4")	25mm (1")	32mm (1" 1/4)	40mm (1" 1/2)
L	mm	110	145	165	130	190	260		300
B	mm	98							
I	mm	190	225	245	228	288	360	380	440
D	in	3/4"			1"	1"	1"1/4	1"1/2	2"
H	mm	90			93		107		114
h	mm	20			21		30	28	33

Device Dial

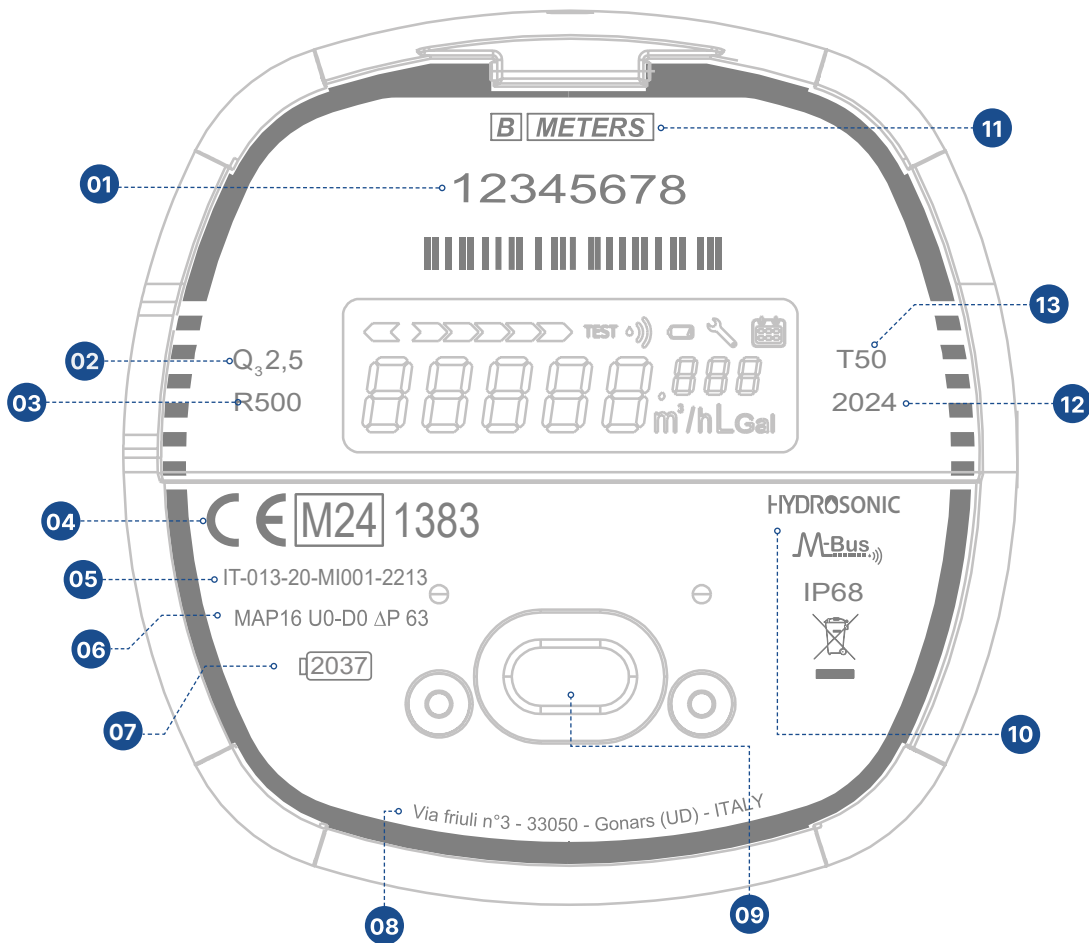

- 01. Serial number
- 02. Q3 meter size
- 03. Measuring class/installation positioning allowed:
RxxH - horizontal installation
RxxVH - vertical and horizontal installation
- 04. CE marking
- 05. Type approval number
- 06. Maximum allowed working pressure
- 07. Battery expiration year
- 08. Company address
- 09. Optical interface
- 10. Type
- 11. Manufacturer
- 12. Year of production
- 13. Temperature class

Functionality

The water meter HYDROSONIC is a water meter with digital display and ultrasonic flow detection. It is available only for cold water.

Types

The device is available in four types:

- Wireless M-Bus OMS v4 (output configuration only Wireless M-Bus OMS v4)
- LoRaWAN (output configuration only LoRaWAN)
- LoRaWAN + Wireless M-Bus OMS v4 (COMBO, output configuration LoraWAN + Wireless M-Bus OMS v4)

Packing content

- Hydrosonic water meter
- Connection gaskets*
- Connectors*
- Seal*

*depending if ordered with the meter

Environmental conditions

- Storage and transportation: from -20°C to +70°C
- Operating: from +1°C to +55°C
- Storage duration does not have to exceed 1 year
- Water meters are precision devices and they have to be protected from shock and vibrations





















Safety conditions

Read carefully all the instructions before proceeding with the installation! Failure to follow one or more of the procedures contained in the manual can be dangerous and cause harm to things and people. Please comply with all applicable safety and accident prevention laws.

 **Attention:** highlights instructions to be followed scrupulously for the correct operation of the water meter.

 **Danger:** the paragraphs highlighted by this symbol contain important information to avoid situations of danger for themselves or for others.

 **Notes:** notes with this symbol contain useful information for better use of the device.

	Comply with the national regulations on water measurement.
	Comply with the technical requirements for the installation of electrical equipment.
	The device complies with the requirements of Directive 2014/30/EU of the European Council on electromagnetic compatibility, Directive 2014/35/EU on electrical safety and Directive RED 2014/53/EU.
	The warranty and validity of the verification before expires if the identification plate and seals attached to the instrument are removed or damaged.
	Air transportation of tools with active radio interface prohibited.
	To clean the device externally use a soft cloth and moistened with water. Do not wash with high pressure jets or immerse the device in water. Avoid contact with oils and solvent. Do not use alcohol or detergents.
	Remove the product from the package only at installation to protect it from damage and dirt.
	If several devices are installed in a unit, the installation conditions must be the same for all devices in order to ensure the most equitable billing of consumption possible.
	Carefully observe the instructions in the data sheet, instruction manual, application notes and lid. Failure to comply with the operating conditions may result in situations of danger and forfeiture of all claims of liability for defects and liability on the basis of any guarantees expressly granted. Further information is available on www.bmeters.com
	Dispose of replaced devices and defective components in accordance with current environmental regulations.
	Do not damage the device casing. In the event of blunt objects hitting the front of the display, it can be damaged irretrievably and lose the degree of protection IP65 or IP68. Install in areas protected against impact. In case of breakage of the protective casing contact customer support.
	The meter is not suitable for running water in central heating systems but is suitable for clean water.
	Pay attention to sharp edges or sharp projections in the threads, flanges and measuring tube. Therefore, it is recommended to wear protective gloves.
	After installation of the meter perform a leak test of the system.
	The meter must be mounted or removed only after the system has been depressurized.
	The meter does not have lightning protection.
	Do not expose the meter to sun and heat sources. Do not throw into the fire.
	The device shall be used in such a way as to minimise the potential for human contact during normal operation. In order to avoid the possibility of exceeding the limits of exposure to radio frequencies, the human proximity to receivers with integrated antenna should not be less than 20 cm (8 inches) during normal operation.
	Keep away from children.
	Water meters do not require special protection against electrical interference; however, electromagnetic interference must be avoided.

	If transmission network interfaces are used, especially when cables are routed outside the building, use more protection against electrical interference.
	In case of danger of frost, empty the system and, if necessary, remove the meter.
	Rinse the pipes thoroughly before installing the meter.
	The meter shall be installed in the direction of the arrow on the meter housing, corresponding to the direction of the flow.
	Avoid collecting air bubbles in the meter during the installation process.
	The meter shall not be subjected to mechanical stress when installed in the pipe.
	The meter shall be installed in a way that it is protected from all external impurities and contamination.
	Remove the old seals and clean the sealing surfaces.
	Slightly grease the sealing surfaces (use grease approved for drinking water and acid-free).
	The meter can only be installed in frost-proof areas.
	Use only the gaskets supplied (the gaskets must not get into the pipe). Seals provided on site must be fit for purpose and comply with local guidelines and directives. No liability is accepted for consequential damage resulting from the use of third-party seals, such as corrosion of seal surfaces and threads.
	Manually and simultaneously screw the meter fittings on both sides and then tighten in opposite directions using a suitable tool.
	Slowly fill the pipe with water after installation.
	The meter must be protected against pressure shocks in the pipe.

The table below presents troubleshooting procedures:

Error	Cause	Troubleshooting
Display off	Batteries may be damaged or discharged.	Notify the service department
Damaged casing	Possible external impact or fall to the ground	
Lower case body separated by electronic unit	Tampering by third parties or strong external impacts	
Open and visible electronic unit		
Consumption is not accounted for	Tampering by third parties, strong external impacts or flow detection sensor damage	
Do not transmit radio signal	Flow failure of 5 liters or the batteries may be damaged or discharged	
Error '____ L Err' present on display	Possible leakage in the water supply/plant/taps	Check for leakage in the water supply/system/tap
Error '____ O Err' present on display	Range higher than Q4 for 10 consecutive minutes	
Error '____ I Err' present on display	Continuous reverse flow greater than 20 liters	

Installations requirements

All water meter versions can be installed both horizontally and vertically.

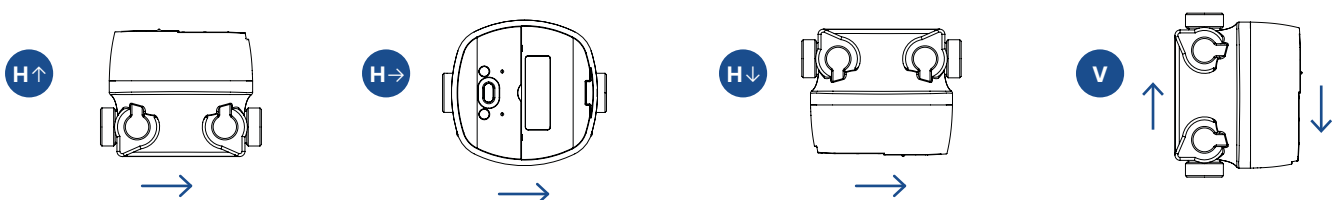

2. Operation

Display

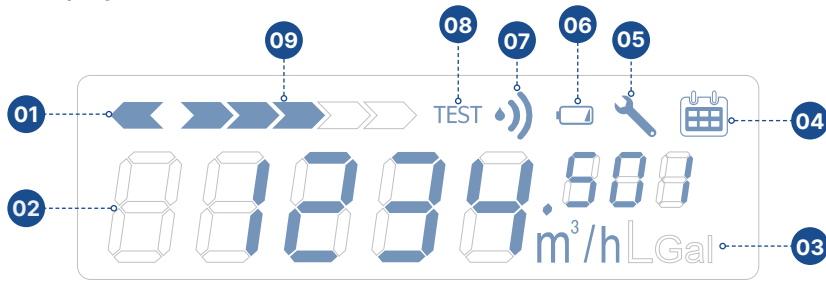

Note: For illustrative representation purposes.

- 01. Reverse flow direction (appears if a flow is detected)
- 02. Main display (m³) internal decimal places (litres)
- 03. Unit of measurement
- 04. Historical data
- 05. Configuration mode/alarm
- 06. Battery warning symbol
- 07. Radio transmission status
- 08. Test mode
- 09. Flow rate (appears if a flow is detected)

3. Radio parameters

Delivery status

The factory setting is on power saving mode. In this mode the radio transmission function is not activated yet, to save battery power during shipment and storage in stock. However, the device can count consumption and send errors (e.g. reverse flow for incorrect installation).

Operating mode - Radio activation

This paragraph describes the operating and radio communication parameters of the device. For the wM-Bus transmission, a test function can be activated via the NFC interface (only before the passage of ± 5 liters), to verify the correct operation of the device. By means of test function the device will transmit for 1 minute a standard data packet with a range of 5 seconds between one packet and another. After this cycle the device will return to the previous mode, waiting for the passage of ± 5 liters.

Radio parameters

Wireless M-Bus – OMS v4 certified (output configuration, only Wireless M-Bus)

At the passage of ± 5 liters, the meter begins to transmit a Wireless M-Bus telegram in T1 mode (synchronous unidirectional transmission).

Preconfigured radio parameters (AMR synchronous mode, OMSv4 certified):

- Transmission frequency: every 200 seconds
- Transmission span: every day, from 0 to 24h
- Encryption: disabled (default)
- No historical data
- Transmitted data: Extended package containing errors, battery percentage, reverse flow data, instantaneous flow, water temperature, CPU temperature, alarm dates (empty pipe, loss, freezing).

These parameters can be changed in Walk-By or Advanced mode via Android app BMetering NFC Config or BMetering software:

- Transmission frequency: configurabile (minimo 60 secondi)
- Transmission span: from Monday to Friday (weekend optional), maximum 12 hours a day
- It is possible to select the active transmission for 24 hours only under the following conditions:
 - Transmission frequency: > 300 seconds (synchronous)
 - No historical send: Historical package not selectable
- Encrypting: enabled/disabled
- Historical data (12 months and historical storage day)
- Transmitted data:
 - Battery value and percentage
 - Errors
 - Standard (max. 10 bytes): date and time, water consumption data, inverted flow data, instantaneous flow rate, water temperature, CPU temperature
 - Extended (max 19 bytes): standard package with the addition of alarm dates (empty pipe, leakage, freezing)
 - Historical (max. 47 bytes): standard package with addition of 12 months previous historical and historical storage day.
 - Memory day (max. 20 bytes); standard package with addition of memory day 1 and 2 data (date and consumption in litres)

Packet data will be transmitted according to the default or NFC settings.

If the frequency is < 200 seconds the transmission is asynchronous, otherwise synchronous.

LoRaWAN (transmission configuration only LoRaWAN)

At the passage of ± 5 liters, the meter starts transmitting a lorawan telegram compliant with version 1.0.3, class A and will require the network server to update the date and time (if available).

Preconfigured parameters:

- Transmission frequency: every 12 hours

- Transmission span: daily, from 0 to 24 h
- Transmitted data: package 'Data Logger' (absolute counting liters of water, 14 hourly values of consumption).
- Immediate alarms: leakage, burst, freezing.

These parameters can be changed via NFC android device and Bmetering NFC Config app or via BMetering software:

- Transmission frequency: based on data rate (refer to the table in lorawan specification)
- Transmission span: daily, from 0 to 24 h
- Transmitted data: depending on the type of uplink chosen (Compact, Extended, Data logger, Monitoring, Alarm History)
- Immediate alarms: refer to the lorawan specification, available by writing to ticket@bmmeters.com
- ABP mode and keys

Combo (output configuration LoraWAN + Wireless wM-BUS)

As soon as radio mode is enabled, the device sends join requests to the provisioned Network Server, according to the lorawan transmission standard. In addition, it activates the transmission according to the standard Wireless M-Bus OMS v4 T1 mode (asynchronous one-way transmission). During the join process, the radio icon on the display will flash every second. If it succeeds, the icon will remain fixed and stable, otherwise it will turn off.

Preconfigured radio parameteres LoRAWAN:



- Transmission frequency: every 12 hours
- Transmission span: daily, from 0 to 24 h
- Transmitted data: package 'Compact' and 'Extended' (absolute counting liters of water, alarms, water temperature, CPU temperature, reverse flow).
- Immediate alarms: Disabled

Preconfigured radio parameteres wM-Bus:

- Transmission frequency: 60 seconds (asynchronous).
- Transmission span: Monday to Friday, from 8 to 18 h.
- Encryption: Disabled
- Transmitted data: 'Historical' package. For the transmitted data please refer to the wM-Bus specification, which can be found by writing to ticket@bmmeters.com.



It is possible to change the configuration parameters via android NFC device and app BMetering NFC config downloadable from the play store or via BMetering software. Refer to the app manual for the list of parameters that can be changed in this mode.

RADIO INDICATORS ON DISPLAY

During the JOIN process, if the lorawan transmission has been activated, the icon  will flash quickly on the display (1s intermittence), until completion and will remain active. If JOIN fails, the icon will turn off. If you use communication only wM-Bus mode the icon will always remain active after the passage ±5 liters. The radio icon  will flash quickly in case of transmission (lorawan or wM-Bus) if the counter has joined or the wM-Bus transmission is active after the passage of ±5 liters.

In case of Combo mode (wM-Bus and lorawan) the lorawan interface takes precedence. If the join procedure is not successful or the device is not connected to the network server, the icon will turn off.

During the test procedure wM-Bus and/or lorawan, the radio icon will activate in the following modes:

- **WMBUS_TEST_MSG**: the icons  e **TEST** will remain active for one minute and flash quickly on the display (1 second intervals) with each transmitted data packet. At the end of the procedure the icons will turn off.
- **LORA_TEST_JOIN**: le icone  e **TEST** will flash quickly on the display (1 second intervals). If the join is executed the icon will remain active for 1 minute and then turn off, otherwise it will continue to flash until all the join attempts are finished. In case of force join, after the passage of ±5 liters, the icon will flash for a cycle of 6 minutes transmitting to each sfx data rate remaining on or off depending on the result of the join.

4. Data display loop

The display will show in sequence the following default information:



Absolute count (m3)*
20 seconds (24 if no alarms are present)

Instantaneous flow rate (m3/h)*
2 seconds

Errors (if any)
4 seconds

Every 130 seconds the display will show the following reduced cycle:

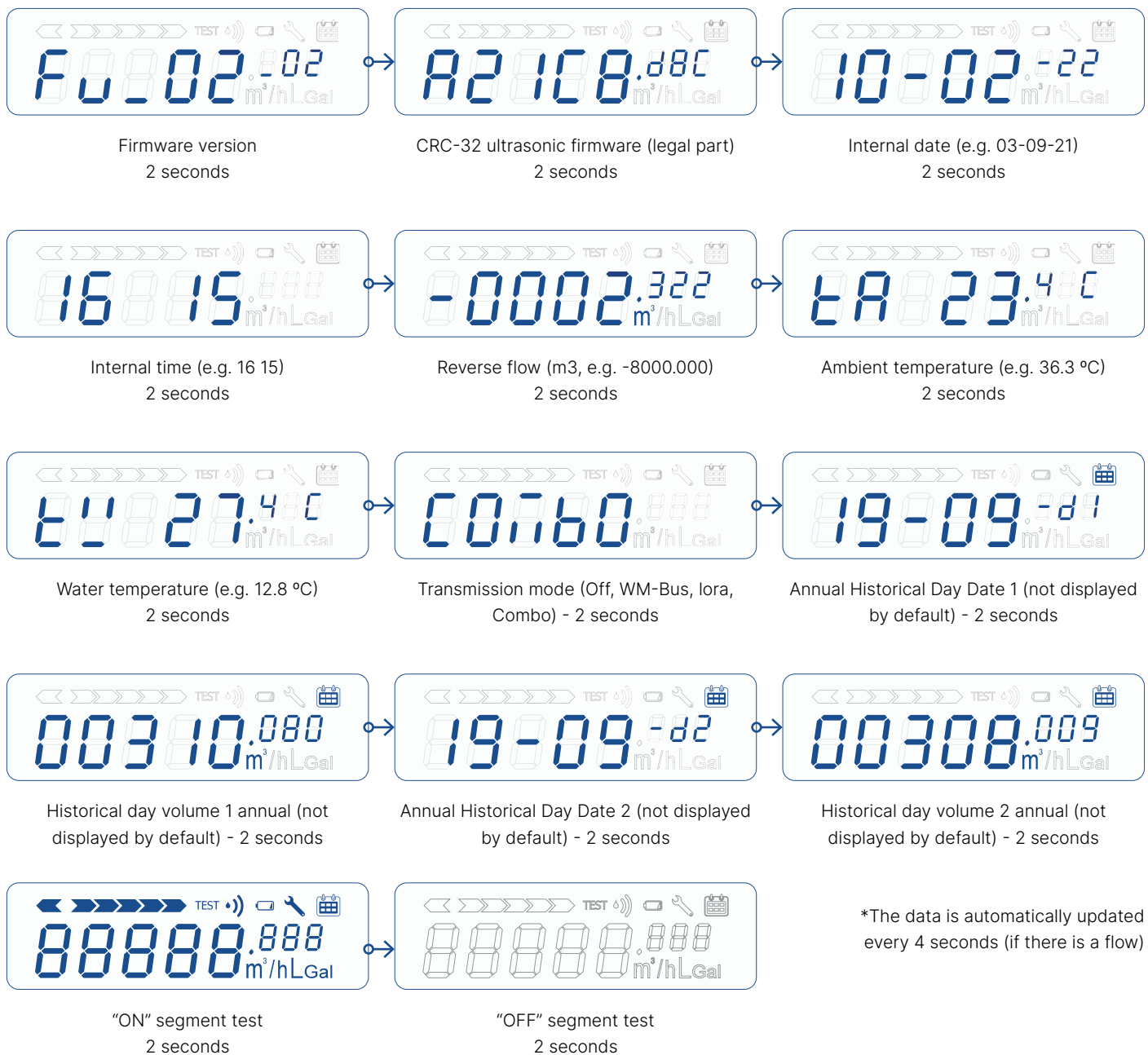

*The data is automatically updated every 4 seconds (if there is a flow)

5. Error message











If an error occurs, an error message is displayed. The error message will be integrated into the device display cycle for 4 seconds.

Error	Display indication (if any)	Description	Error type	Troubleshooting
TAMPERING	' t '	Ultrasonic card disconnection detected (fraud).	Permanent	Contact Supplier
RESERVED	' A '	Reserved		
	' M '			
RESERVED	' U '			
REVERSE INSTALLATION	' r '	Only during the first installation, if the meter starts from 0 liters and an inverse flow is detected (greater than 8 liters).	Temporary	Automatically when the initial condition is restored.
EMPTY PIPE	' E '	The tube is not full or there are air bubbles that disturb the ultrasonic signal. The activation date is recorded.		

FREEZING	' F '	A minimum water temperature < 2 is detected. C. The activation date is recorded.	Permanent	Reset via NFC or LORA.
QMAX OVERFLOW	' O '	The counter shall operate at a flow rate exceeding Q4 for 10 consecutive minutes. The activation date shall be recorded.	Permanent	Reset via NFC or LORA.
LEAKAGE	' L '	The meter detects a continuous flow >0.5*Q1 for 12 hours. The alarm resets when the flow average in 5 minutes is below the threshold indicated above. The date of the resolved loss will then be recorded. The threshold can be set via NFC or LORA (minimum 1 hour).	Temporary	Automatically when the initial condition is restored.
BURST	' b '	The flow rate of the meter remains continuously above Q3 for 30 minutes.		
REVERSE FLOW	' I '	Continuous reverse flow greater than 200 liters. Threshold can be set via NFC or LORA (minimum 20 liters). The activation date is recorded.	Permanent	Reset via NFC or LORA.
NO CONSUMPTION	' c '	Flow detected for 7 consecutive days (minimum). Threshold can be set via NFC or LORA.	Temporary	Automatically when flow is detected.
RESET	' S '	Device restarted for any external cause.	Permanent	Reset via NFC or LORA.
EXCESSIVE TEMPERATURE	' h '	An ambient temperature of > 55 °C is recorded. The activation date is recorded.		Contact supplier
END BATTERY LIFE		Low battery		Reset via NFC or LORA.
NFC FRAUD	' n '	Continuous NFC field detected for several consecutive minutes.		Update date and time via NFC or LORA.
RTC	' P '	Sudden reset of date and time detected.		

6. Battery safety guidelines

The water meter constantly monitors the status of the battery (**maximum life: 13 or 16 years****) and signals the imminent discharge by displaying the icon  on the display. The report takes place one year before the total discharge. [Non replaceable batteries.](#)

	The meter uses non-rechargeable batteries that, if misused with, can be potentially dangerous. To reduce the risks, you should take the following precautions.
	Do not recharge or replace the battery
	Do not open, puncture or damage batteries;
	Do not short-circuit batteries;
	Do not expose batteries to temperatures above 85 °C;
	Do not insert into ovens, crush or cut: these actions could cause an explosion or leakage of flammable gases or liquids;
	Do not use naked flames near the device;
	Do not put in contact with water;
	Do not expose the battery to an extremely low pressure environment which could cause an explosion, a gas or flammable liquids leak;
	Always dispose of batteries in compliance with current regulations;
	Always use original spare parts authorized by the manufacturer.

*Battery life depends heavily on the working time window, set during the configuration process, and the environmental conditions. The battery life estimate is provided by the configuration software.

**Standard version: 13 years maximum life; On request version: up to 16 years maximum life.

7. Information for the correct disposal

 This product falls within the scope of Directive 2012/19/EU on the management of waste electrical and electronic equipment (RAEE). The appliance should not be disposed of with household waste as it consists of different materials that can be recycled at the appropriate facilities. Inquire through the municipal authority about the location of the ecological platforms to receive the product for disposal and its subsequent proper recycling. The product is not potentially dangerous to human health and the environment, but if abandoned in the environment impacts negatively on the ecosystem. The crossed-out bin symbol on the label on the appliance indicates that the product complies with the legislation on waste electrical and electronic equipment. The abandonment of the equipment in the environment or the improper disposal of the same is punished by law.

8. Technical data

Model	HYDROSONIC
Metrological class	R250 R400 R500 (on request)
Flow detection technology	Ultrasonic
Temperature class	T50 cold water (from +0,1°C to 50°C)
Display	LCD, 8 digits + icons
Protection class	IP68*
Local interface	NFC
Radio standard	- Wireless M-Bus EN 13757-4 OMS v4; - LoRaWAN 1.0.3; - LoRaWAN 1.0.3 + Wireless M-Bus EN 13757-4 OMS v4.
Radio frequency	868 MHz
Radio range / radio power	Wireless M-Bus: 300 meters** LoRaWAN: 5 Km**
Battery life	Standard version: max 13 years*** On request version: max 16 years***
Cut-off	The meter does not count volume below $1/3 \cdot Q^1$
Permitted installations	Any

* IP68: maximum 24 hours continuous immersion at 1 m depth.

Note: In case of damage caused by accidental impact, the meter must be replaced with a new one, to restore the degree of protection.

** In optimal propagation conditions, the radio range depends on physical conditions (building construction, climatic conditions...) where the propagation of the radio signal can therefore vary.

*** Battery life depends heavily on the working time window, set during the configuration process, and the environmental conditions. The battery life estimated is provided by the configuration software.



EU DECLARATION OF CONFORMITY

dichiarazione di conformità CE

Water meter product type/model:
Modello di contatore per acqua:

HYDROSONIC

Name and address of the manufacturer:
Nome e indirizzo del fabbricante

BMETERS S.r.l. Via del Friuli, 3 – 33050 Gonars (UDINE) ITALY

This declaration of conformity is issued under the sole responsibility of the manufacturer.
La presente dichiarazione di conformità è emessa sotto la responsabilità del fabbricante.

Object of declaration:
Oggetto della dichiarazione:

Ultrasonic Water Meter
Contatore per acqua ad ultrasuoni

Above mentioned object is in conformity with relevant EU harmonization legislation:
L'oggetto sopra menzionato è conforme alla normativa di armonizzazione dell'UE pertinente:

Directive No. 2014/32/EU and 2014/53/EU (RED) and Directive 2011/65/EU (RoHS)
Direttiva No. 2014/32/UE e 2014/53/UE (RED) e Direttiva 2011/65/UE (RoHS)

Relevant harmonized standards and normative documents and references to the other technical specifications used for declaration:
Norme armonizzate pertinenti e documenti normativi e riferimenti alle altre specifiche tecniche utilizzate per la dichiarazione:

EN ISO 4064-1:2017
EN ISO 4064-2:2017 §8.11, §8.12
EN ISO 4064-3:2017
EN ISO 4064-5:2017

OIML R 49-1:2013
OIML R 49-2:2013
OIML R 49-3:2013
Welmec Guide 7.2 rev.5

EN 301 489-1:2017 v2.2.0
EN 301 489-3:2017 v2.1.1
ETSI EN 300 220-1:v3.1.1
ETSI EN 300 220-2: v3.2.1

Name and number of notified body:
Nome e numero dell' organismo notificato:

Parco Scientifico e Tecnologico del Lazio Meridionale scrl
Via Casilina Nord 246 km 68 03013 – Ferentino (FR) Italy

Certificate issued:
Certificato emesso:

EU type certification in accordance with Module B of Directive No. 2014/32/EU
Certificazione UE di tipo in conformità al Modulo B della Direttiva n. 2014/32/UE

Issue the Certificate No:
Numero del certificato emesso:

IT-013-20-MI001-2213

Name and number of notified body:
Nome e numero dell' organismo notificato:

CMI Český metrologický institut, NB 1383 Okružní 31
638 00 Brno Czech Republic

Certificate issued:
Certificato emesso:

Certification of production, final product inspection and testing in accordance with Module D of Directive No. 2014/32/EU
Certificazione della produzione, ispezione del prodotto finito e collaudo in conformità al Modulo D della Direttiva n. 2014/32/UE

Issue the Certificate No:
Numero del certificato emesso:

0119-SJ-A011-08

Signed by the General Manager on behalf of BMETERS S.r.l.:
Firma del Direttore generale Per conto di BMETERS S.r.l.:

Mr. Mauro Budai

B. METERS s.r.l.
Via Friuli, 3
33050 GONARS (UD) C. F. e P. IVA 01750.40.17

Place and date of declaration issue:
Luogo e data di emissione della dichiarazione:

Gonars, Italy, January 08, 2024
Gonars, Italia, 08 Gennaio 2024